

**An Important  
Public Service Message  
about Plumbing Code  
Compliance for the  
protection and  
conservation of your  
safe drinking water**



Backflow Devices are being installed on all connections... Please read this brochure to see what you must do to protect your home plumbing.

watts.com

**WATTS®**

**Backflow  
prevention  
programs  
are required  
to assure  
safe water  
for drinking  
bathing and cooking**

Dear Neighbor:

Safe drinking water. It is one of our most precious natural resources. It is our job to provide and protect the safe drinking water supply. It is a responsibility that we share with you, since you use the water, and because your plumbing system is tied into the community water system.

Here is our part: to regulate the public water supply and to ensure that reasonable safety measures are taken to protect the safe drinking water from the point of treatment to the point of use – your home or business. We must meet all Department of Health and EPA Standards.

Here is your part: to make sure that your plumbing system is safe.

We have prepared this brochure to inform you about the principles of water safety and conservation. Please take the time to read it. If you have any questions, please call us at the customer service number listed on your bill.

By working together, we can keep our drinking water safe, for the good of our families and our community.

Sincerely,  
Your Water Supplier

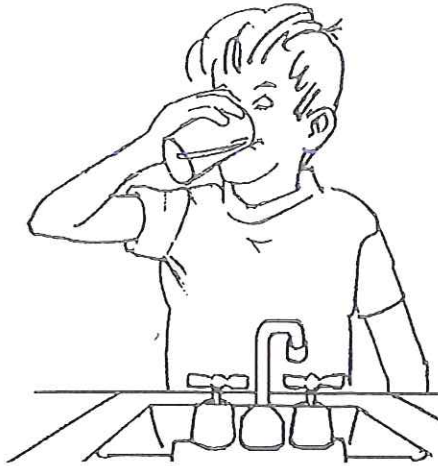

## **The Plumbing Code in Our Community is the Uniform Plumbing Code.**

### **Maintenance**

Section 101.4.1.3: The plumbing and drainage system of any premises under the jurisdiction of the Administrative Authority shall be maintained in a sanitary and safe operating condition by the owner or his agent.

### **Cross Connection Control**

Section 603.0: No person shall install any water operated equipment or mechanism, or use any water treating chemical or substance, if it is found that such equipment, mechanism, chemical or substance may cause pollution of the domestic water supply. Such equipment or mechanism may be permitted only when equipped with an approved backflow prevention assembly.

### **Water Conservation - Excessive Water Pressure**

Section 608.2: Where local static water pressure is in excess of eighty (80) pounds per square inch (551 kPa), an approved type pressure regulator preceded by an adequate strainer shall be installed and the static pressure reduced to eighty (80) pounds per square inch (551 kPa) or less.

# WATER SAFETY

Every year across America, hundreds of people are injured or killed because of drinking water system-related accidents in their own homes. Examples include drain cleaner being sucked back into the water system and coming out in the shower; pesticides being sucked back into the garden hose, and then being filled into someone's drinking glass.

While these incidents are not very pleasant to think about, the good news is that you can prevent them.

The key to water system safety is this: whenever safe drinking water leaves the piping, it must do so through a physical air gap or a mechanical backflow preventer, as required by the plumbing code, to keep any contaminated water from entering the safe drinking water.

As you read this booklet, take a walk around your house and check out all the plumbing fixtures. If your house does not have a particular fixture we talk about, simply skip that section.

Ready? Let's go!

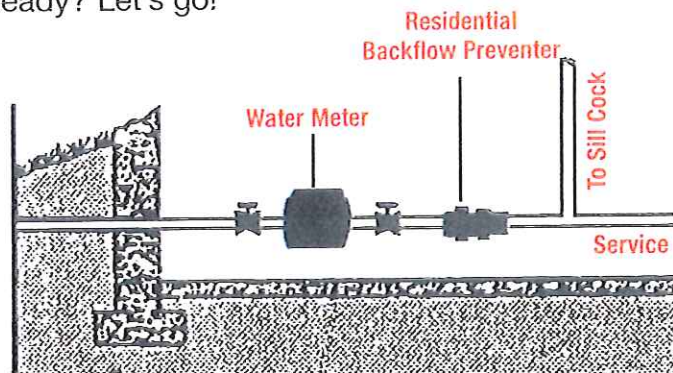

## 1. Water Meter

The water meter is the point where the community water supply enters your system. You must have a water meter and a backflow preventer assembly installed. The installation of a backflow preventer at the service entrance should be done by a licensed plumber.

You must protect your system from thermal expansion after installing a backflow preventer at the service entrance. Use either an expansion tank or an anti-siphon ball cock assembly with relief feature. Both are effective, the latter is less expensive.

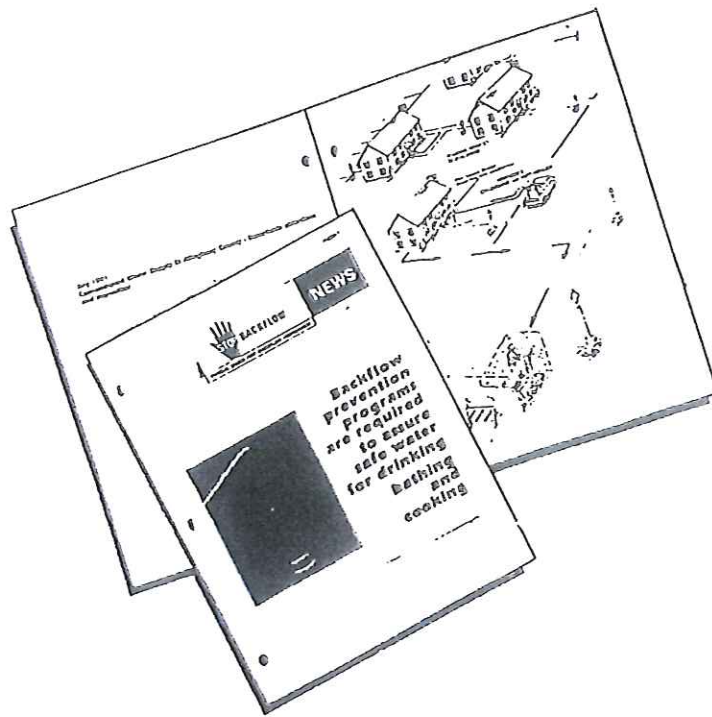

## 2. Kitchen Sink

The faucets on your kitchen sink are standard plumbing fixtures. Since they are designed to protect you automatically, you don't need to do anything to make them safe. The manufacturer does this by providing an air gap between the end of the faucet and the overflow water line of the sink. All you have to do is keep them safe.

A typical unsafe condition occurs when a hose on the end of the faucet is submerged into dirty water in the sink. The dirty water can be drawn back into the safe drinking water supply.



### 3. Toilet

When water leaves the drinking water supply system and flows into your toilet tank, the water should be prevented from being drawn back into the water supply. The water in the toilet tank is often treated with cleansing chemicals that are not safe to drink.

There is something you can do. Make sure an anti-siphon ballcock assembly is in your toilet tank. This will protect against backsiphonage. The ball cock can also serve as a thermal expansion relief device, if equipped with an auxiliary relief valve. The relief valve should govern the preset pressure to 80psi or less.

**You must equip your toilet with the thermal expansion relief device to prevent damage to your plumbing system. A qualified plumber can help you or these devices can be purchased at your local plumbing supply store.**

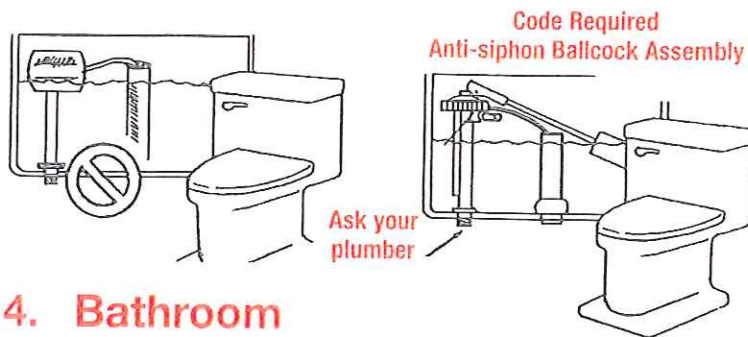

### 4. Bathroom

The sink and bathtub faucets are generally protected by air gaps. The only thing that can cause a problem is if someone puts a hand-held sprayer on the faucet and it is submerged in bath water. Here you would need a special hose vacuum breaker. There is nothing that needs to be added to increase the safety of your standard bathtub.

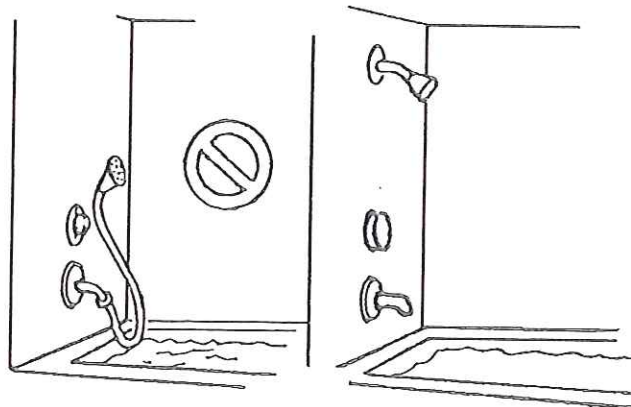

## 5. Water Heater

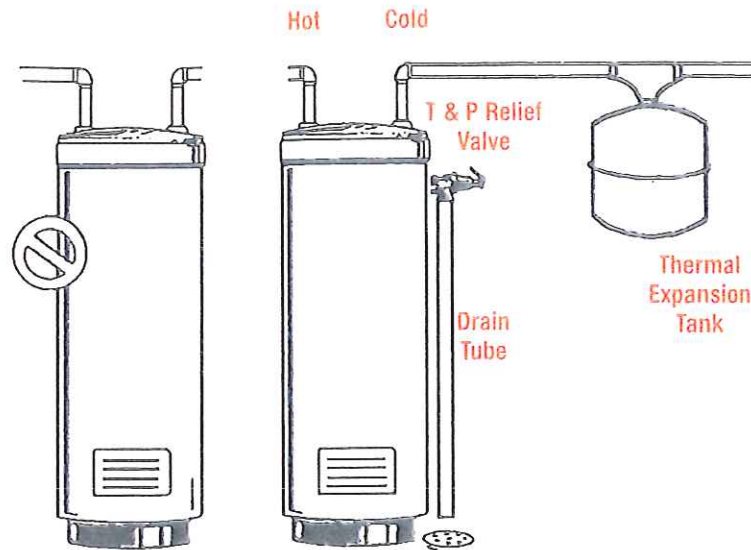

Thermal Expansion occurs whenever water is heated. The backflow preventer prevents the expanded water produced by a water heater from returning to the community supply. Since water cannot be compressed, the expanded water volume can cause a rapid increase in pressure in the piping. Often the pressure will exceed the setting of the temperature and pressure safety relief valve located on the water heater. This will result in a loss of hot water at the relief valve and, more importantly, it can shorten the life of this very important safety device.

### **CAUTION:**

#### **Never plug a dripping safety relief valve!**

This is important because a water heater can explode if excessive temperature and pressure build-up. Water heaters must have a temperature and pressure relief valve. It is your responsibility to check the system every three years to make sure the safety valve is in good working order.

The system can be protected by using a potable water expansion tank which absorbs the thermal expansion and maintains a balanced system pressure or by use of an anti-siphon ball cock assembly. (See item No. 3)

## 6. Laundry Sink

(A) To make your laundry sink safe, you need a hose bibb vacuum breaker. This is a small, inexpensive device that simply attaches to the threaded end of the faucet as with your outside water faucets (sill cocks).

(B) Modern sinks do not require added protection because they are protected by an air gap.

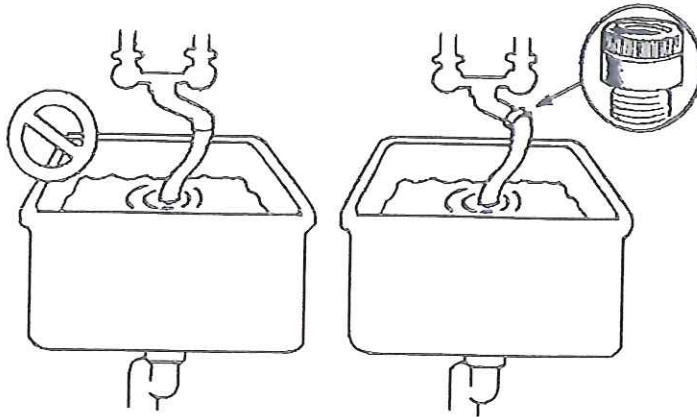

## 7. Washing Machine

Your washing machine has a built-in air gap installed at the factory. You can also install a single lever washing machine shutoff valve that easily shuts off the hot and cold water simultaneously, and protects against flooding. There is a possibility that the hose might rupture and flood your basement or laundry room while you are away.

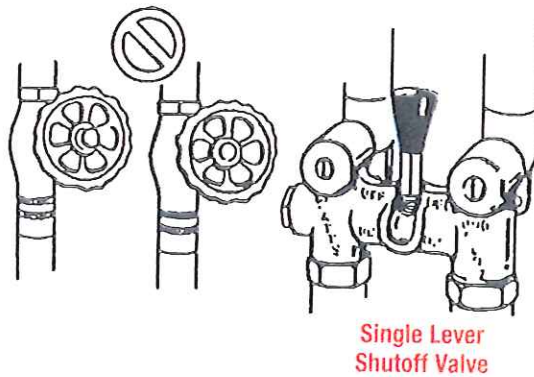



## 8. Outdoor Faucet

The ordinary garden hose is the most common way to contaminate the water supply. This can happen when one end of a common garden hose is attached to an outdoor faucet (sill cock), and the other end of the hose connects to an aspirator type bottle. Insecticides or other chemicals in the aspirator bottle can be siphoned back into the drinking water supply.

You can easily prevent the possibility of this type of contamination by installing a hose bibb vacuum breaker. This is a small, inexpensive device that simply attaches to a threaded water faucet.

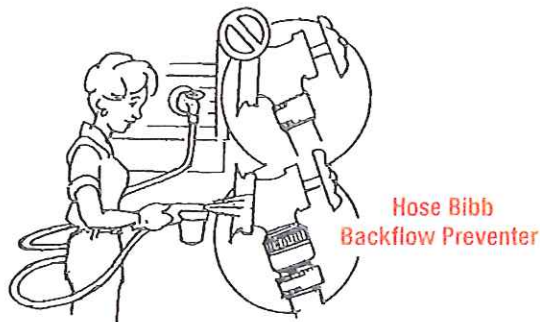

## 9. Heating/Cooling Systems

You may use a hot water system to heat your home. You can ensure the protection of the safe drinking water system by making sure a backflow preventer assembly is installed. This will protect you against stagnant or chemically treated water from recirculating back into the water supply. Consult a licensed plumber.

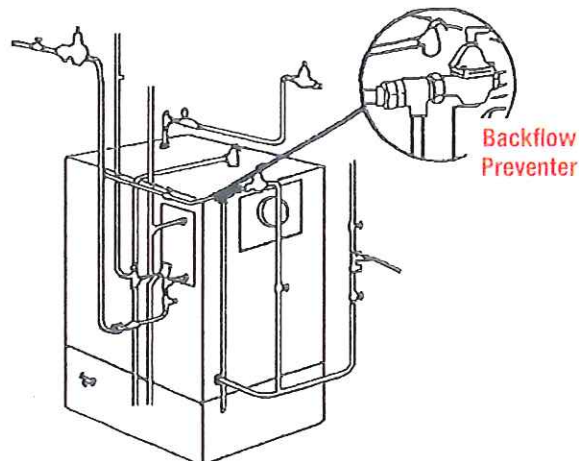

## 10. Lawn Irrigation System

You may have a lawn irrigation system. You will need a vacuum breaker backflow preventer to protect against lawn and pesticide chemicals from being drawn in from your lawn and back into the water supply. Consult a professional lawn irrigation contractor or a licensed plumber.

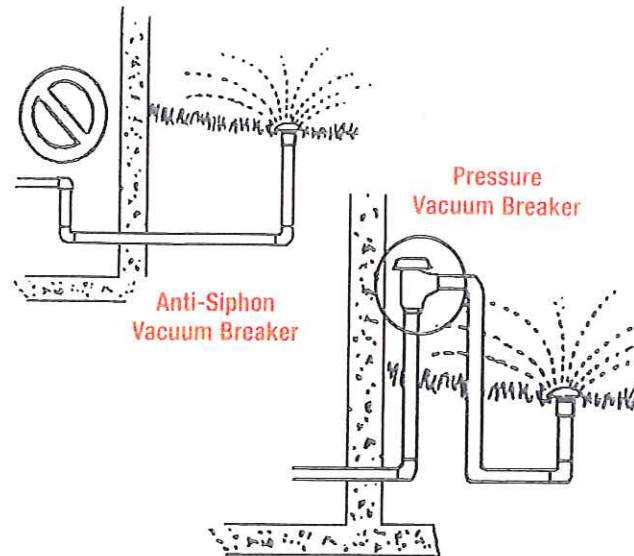

## 11. Home Water Conditioning Systems

Water Filtration, Water Softener, Water Treatment

If you have a water treatment or filtration system with a drain hooked up to the sewer, you need an air gap between the drain line and the drain connection.

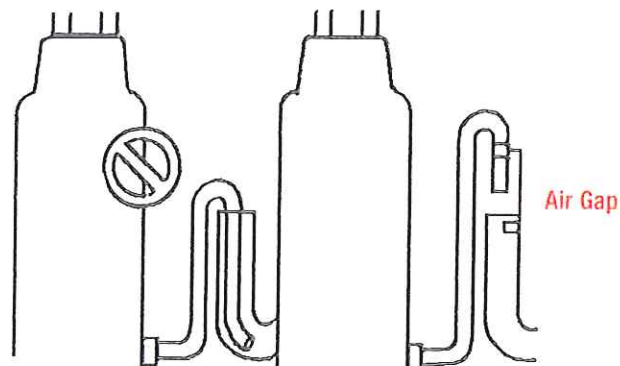

## 12. Home Photography Darkroom

Chemicals are needed to develop photographs. You need a vacuum breaker backflow preventer to ensure that the chemicals will not enter the water supply.

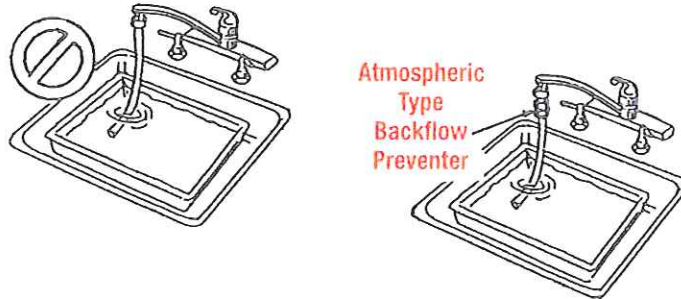

## Helpful Hints

You may benefit from these tips.

### 1. Banging Water Pipes

Do your water pipes bang when you turn off the water or when your washer turns off? Not only is this annoyingly noisy, but it stirs up rust in the pipes which can come out in your drinking water, bath, or washing machine.

There is an easy way to prevent banging pipes, and that is to install an inexpensive device called a water hammer arrestor.

### 2. Water Quality

**Copper water piping joints may contain lead solder.** We recommend the flow of water for approximately two (2) minutes to purge the standing water out of the pipes to minimize the ingestion of lead which may have leached into the drinking water.

### 3. Tips on Water Saving

- Put a stopper in the sink or use a dishpan when washing dishes - washing with running water can use 30 gallons per meal.
- Keep a bottle of drinking water in the refrigerator - running the water from the faucet until cold can waste a gallon.
- Wait until you have a full nine pound wash before running the washing machine. The average machine uses 50 gallons per load.
- Turn the hot water off while shaving, and turn the cold water off while brushing teeth. Shaving with a running faucet uses about 20 gallons.
- Take showers instead of baths. The usual bath requires 36 gallons, the usual shower only 25. Ten gallons is enough for a shower if the water is turned off while washing.
- Do not use the toilet bowl to dispose of cigarette ashes, facial tissues and other materials. A normal flush requires 5 to 8 gallons.
- Use the dishwasher only when it is completely full.
- Fix dripping faucets promptly. Nearly 2 gallons can be wasted per day due to dripping.
- Running toilets can waste 4 gallons per hour. Keep them in good repair.
- Above all, THINK before turning on the tap.
- Do not over water lawns and gardens. An irrigation system generally helps to save water, however, automatic systems must have time settings adjusted to respond to the season.

*Printed as a Public Service Message by:  
Watts, No. Andover, MA*



*A Watts Water Technologies Company*

USA: No. Andover, MA • Tel. (978) 688-1811 • Fax: (978) 794-1848 • [www.watts.com](http://www.watts.com)  
Canada: Burlington, ON • Tel. (905) 332-4090 • Fax: (905) 332-7068 • [www.wattscanada.ca](http://www.wattscanada.ca)